

Digital Transistors (Built-in Resistors)

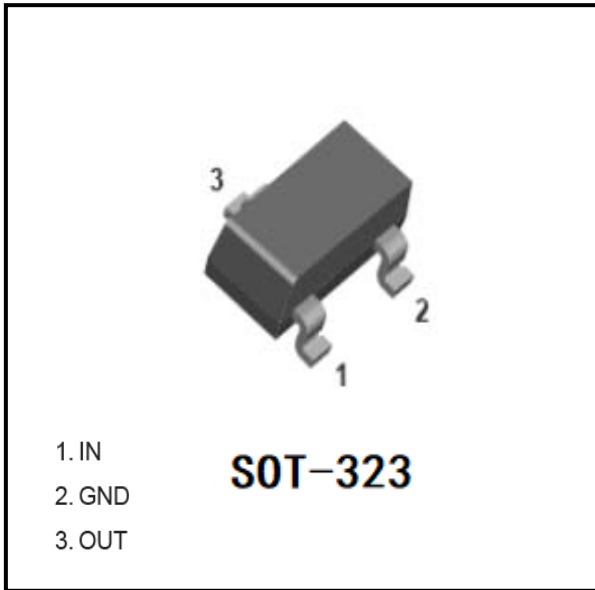

Features

- Epoxy meets UL-94 V-0 flammability rating
- Moisture Sensitivity Level 1
- Built-in bias resistors enable the configuration of an inverter circuit without connecting external input resistors
- Surface mount package ideally Suited for Automatic Insertion
- NPN

Mechanical Data

- **Package:** SOT-323
- **Terminals:** Tin plated leads, solderable per J-STD-002 and JESD22-B102
- **Marking:** 43

■Equivalent circuit

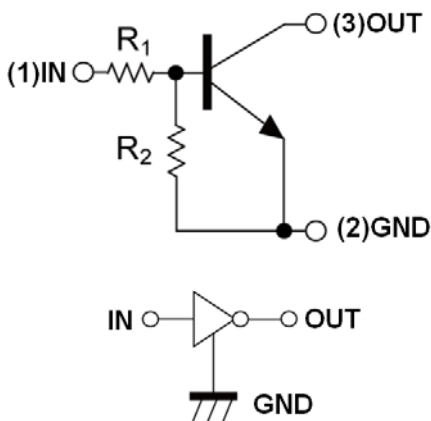

■Maximum Ratings (Ta=25°C Unless otherwise specified)

Item	Symbol	Unit	Conditions	Value
Supply Voltage	V_{CC}	V		50
Input Voltage	V_{IN}	V		-7 to +20
Output Current	I_o	mA		100
Power Dissipation	P_D	mW		200
Junction Temperature	T_J	°C		150
Storage Temperature	T_{STG}	°C		-55 to +150



DTC143XUA

■ Electrical Characteristics (Ta=25°C unless otherwise specified)

Item	Symbol	Unit	Conditions	Min	Typ	Max
Input voltage	$V_{I(off)}$	V	$V_{CC}=5V, I_c=100\mu A$	0.3		
	$V_{I(on)}$	V	$V_o=0.3V, I_c=20mA$			2.5
Output voltage	$V_{O(on)}$	V	$I_o / I_i = 10mA/0.5 mA$			0.3
Output current	$I_{O(off)}$	μA	$V_{CC}=50V, V_i=0$			0.5
DC current gain	GI		$V_o=5V, I_o=10mA$	30		
Input resistance	R_1	$k\Omega$		3.29	4.7	6.11
Resistance ratio	R_2/R_1			1.7	2.1	2.6
Transition frequency	fT	MHz	$V_o=10V, I_o=5mA, f=100MHz$		250	

■ Ordering Information (Example)

PREFERRED P/N	PACKING CODE	UNIT WEIGHT(g)	MINIMUM PACKAGE(pcs)	INNER BOX QUANTITY(pcs)	OUTER CARTON QUANTITY(pcs)	DELIVERY MODE
DTC143XUA	F2	Approximate 0.005	3000	30000	120000	7" reel



Characteristics (Typical)

ON Characteristics

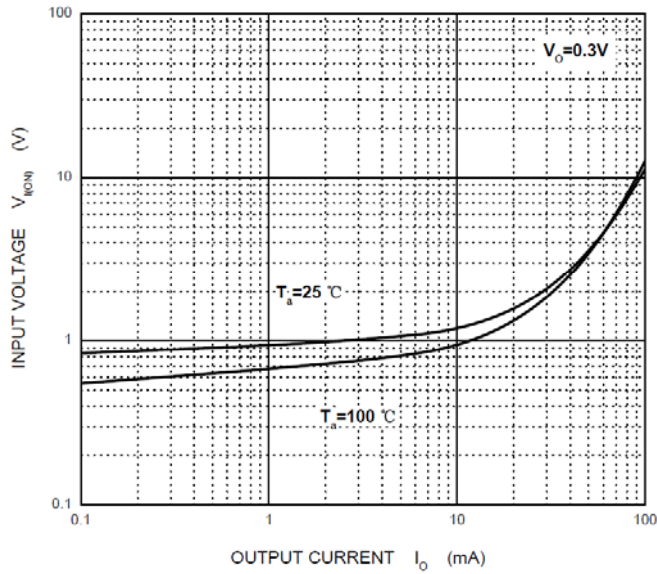

OFF Characteristics

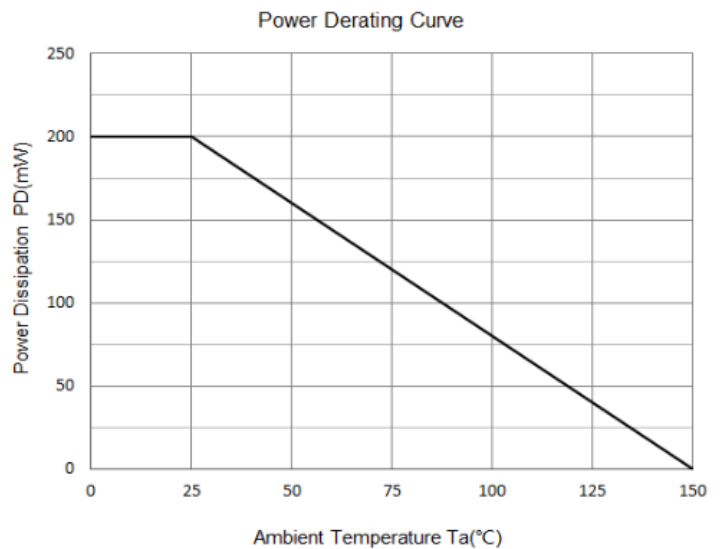
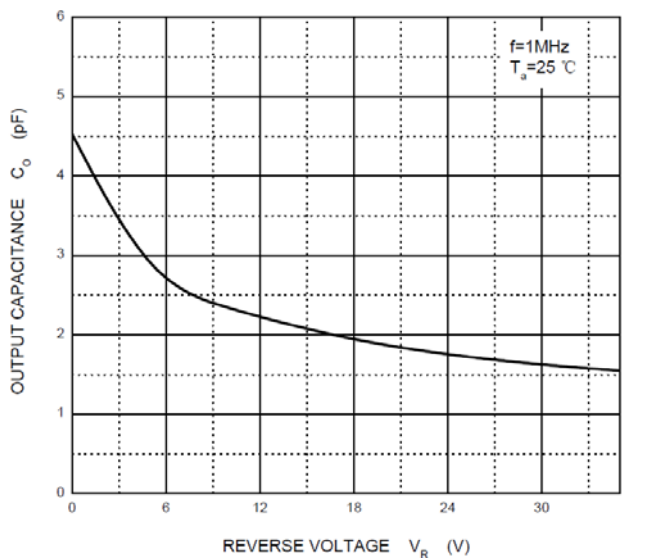
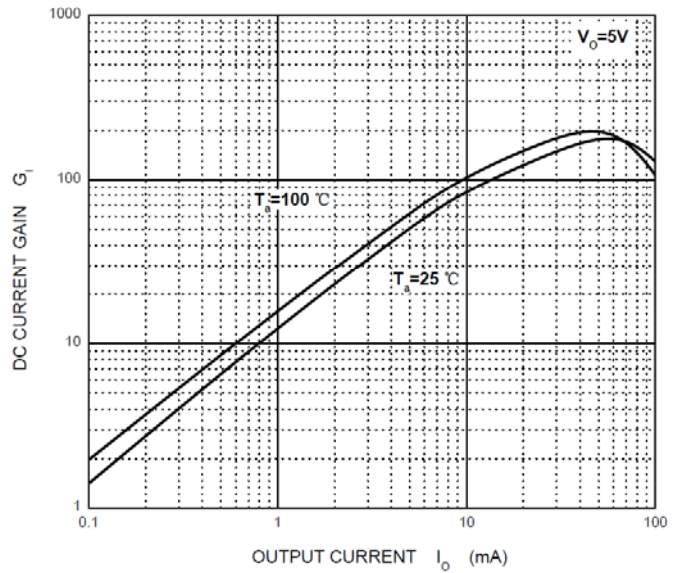
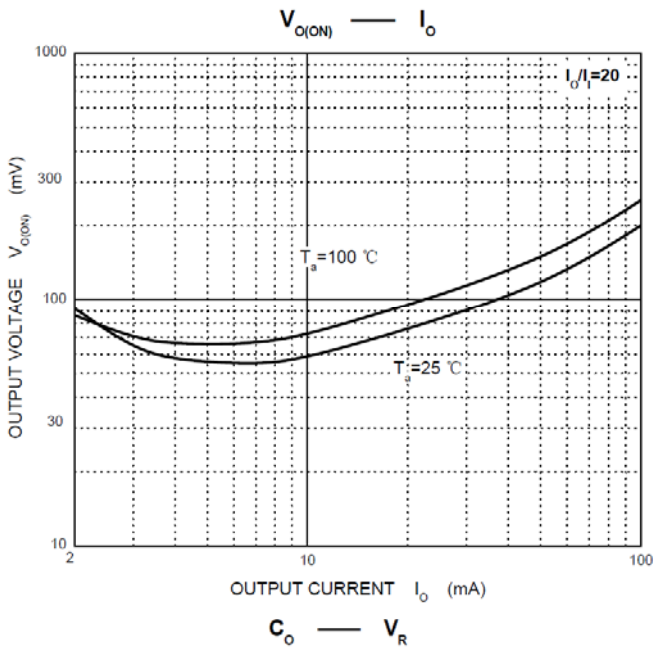
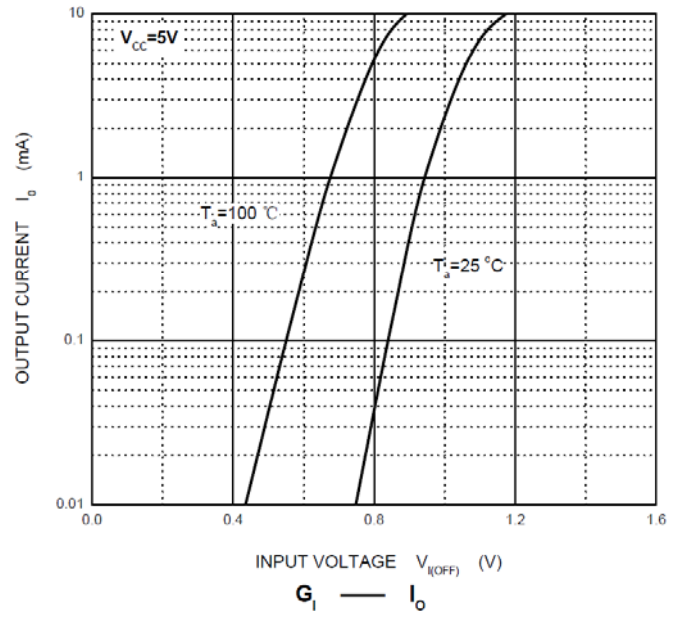



DTC143XUA

■ SOT-323 Package Outline Dimensions

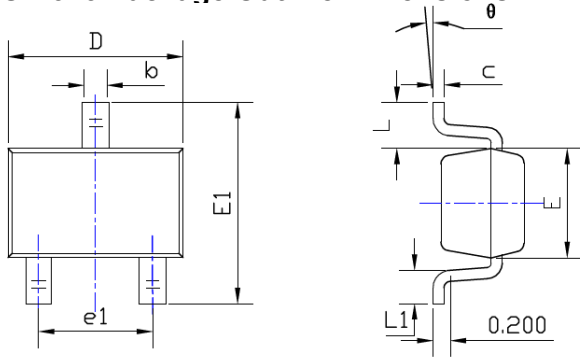

TOP VIEW

SIDE VIEW

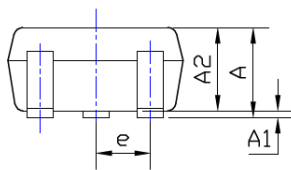

SIDE VIEW

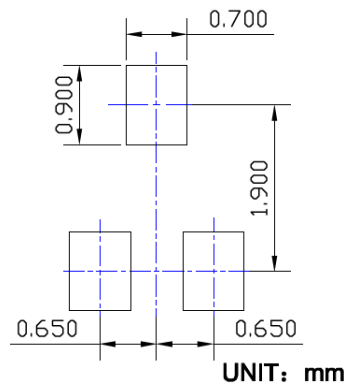

SUGGESTED SOLDER PAD LAYOUT

SYMBOL	DIMENSIONS			
	INCHES		Millimeter	
	MIN.	MAX.	MIN.	MAX.
A	0.035	0.043	0.900	1.100
A1	0.000	0.004	0.000	0.100
A2	0.035	0.039	0.900	1.000
b	0.006	0.016	0.150	0.400
c	0.004	0.010	0.100	0.250
D	0.071	0.087	1.800	2.200
E	0.045	0.053	1.150	1.350
E1	0.085	0.096	2.150	2.450
e	0.026TYP		0.650TYP	
e1	0.047	0.055	1.200	1.400
L	0.021REF		0.525REF	
L1	0.010	0.018	0.260	0.460
θ	0°	8°	0°	8°

NOTE:

- 1.PACKAGE BODY SIZES EXCLUDE MOLD FLASH AND GATE BURRS.
- 2.TOLERANCE 0.1mm UNLESS OTHERWISE SPECIFIED.
- 3.THE PAD LAYOUT IS FOR REFERENCE PURPOSES ONLY.

Note:

1. All dimensions are in millimeters (mm) unless otherwise specified.
[所有尺寸均以毫米为单位, 除非另有说明]
2. General tolerances: $\pm 0.10\text{mm}$ unless otherwise specified.
[通用公差为 $\pm 0.10\text{mm}$, 除非另有说明]
3. Dimensions and tolerances per ASME Y14.5M-2018.
[尺寸和公差遵循 ASME Y14.5M-2018 标准]
4. All dimensions shown are exclusive of burrs and gate residues.
Burrs and gate vestiges shall not exceed 0.15 mm in maximum.
[所有尺寸均不包括毛刺和浇口残留。毛刺与浇口残留的尺寸最大不得超过 0.15mm]
5. Dimension b does not include dambar protrusion of max 0.100 mm per side.
[尺寸b不包括单边最大0.100 MM的中筋凸出部分]
6. Dimensions D and E are the overall extreme outer dimensions of the mold compound. These dimensions exclude mold flash, lead flash, protrusions and burrs but include the maximum allowable mold mismatch.
[D和E是塑封体的外部极限尺寸, 不包括包封溢料、内引线溢料、凸出部分以及胶体毛刺, 但是包含了包封错位的最大尺寸]
7. Formed leads shall be planar with respect to one another within a maximum of 0.076 mm relative to the seating plane.
[成型的管脚应为同一平面, 共面性最大为0.1mm]
8. ★It is the key size.
[★ 标记为关键尺寸]



Disclaimer

The information presented in this document is for reference only. Yangzhou Yangjie Electronic Technology Co., Ltd. reserves the right to make changes without notice for the specification of the products displayed herein to improve reliability, function or design or otherwise.

The product listed herein is designed to be used with ordinary electronic equipment or devices, and not designed to be used with equipment or devices which require high level of reliability and the malfunction of which would directly endanger human life (such as medical instruments, transportation equipment, aerospace machinery, nuclear-reactor controllers, fuel controllers and other safety devices), Yangjie or anyone on its behalf, assumes no responsibility or liability for any damages resulting from such improper use of sale.

This publication supersedes & replaces all information previously supplied. For additional information, please visit our website [http:// www.21yangjie.com](http://www.21yangjie.com) , or consult your nearest Yangjie's sales office for further assistance.