

## Schottky Barrier Rectifier

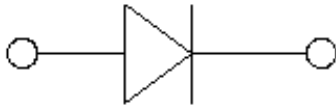

### Features

- Moisture sensitivity level 1
- Reverse voltage: 100V
- Average forward current : 200mA

### Application

- High frequency and low voltage rectifier

### Mechanical data

- **Package:** SOD-323
- **Terminals:** Tin plated leads, solderable per J-STD-002 and JESD22-B102

### ■ Maximum Ratings (T<sub>a</sub>=25°C Unless otherwise specified)

Parameter	Symbol	Unit	Value
Device marking code			41
Repetitive peak reverse voltage	V <sub>RRM</sub>	V	100
Forward current	I <sub>F</sub>	mA	200
Non-repetitive surge peak forward current @ t=1ms square wave	I <sub>FSM</sub>	A	1
Repetitive Peak Forward Current @ t <sub>p</sub> =1ms, δ=0.25	I <sub>FRM</sub>	A	0.5
Power dissipation	P <sub>D</sub>	mW	150
Junction temperature	T <sub>J</sub>	°C	-55 to +150
Storage temperature	T <sub>STG</sub>	°C	-55 to +150



# BAT41WS

## ■ Electrical Characteristics (T<sub>a</sub>=25°C Unless otherwise specified)

Parameter	Symbol	Unit	Conditions	Min	Typ	Max
Reverse voltage	V <sub>R</sub>	V	I <sub>R</sub> =100uA	100		
Forward voltage	V <sub>F1</sub>	V	I <sub>F</sub> =1mA			0.45
	V <sub>F2</sub>		I <sub>F</sub> =200mA			1
Reverse leakage current	I <sub>R</sub>	uA	V <sub>R</sub> =50V			0.1
Junction capacitance	C <sub>j</sub>	pF	V <sub>R</sub> =1V, f =1MHz			10
Reverse recovery time	T <sub>rr</sub>	ns	I <sub>F</sub> =I <sub>R</sub> =10mA, I <sub>rr</sub> =0.1*I <sub>R</sub> ,R <sub>L</sub> =100Ω			4

## ■ Thermal Characteristics

Parameter	Symbol	Unit	Value
Thermal resistance, junction-to-ambient	R <sub>θJ-A</sub> <sup>(1)</sup>	°C/W	667
Thermal resistance, junction-to-case	R <sub>θJ-C</sub> <sup>(1)</sup>	°C/W	533

Note:

(1) Thermal resistance from junction to ambient and from junction to case mounted on P.C.B. with 8mm\*9mm copper pad areas



# BAT41WS

## ■ Characteristics

Fig 1: P<sub>D</sub>-T<sub>a</sub> Curve

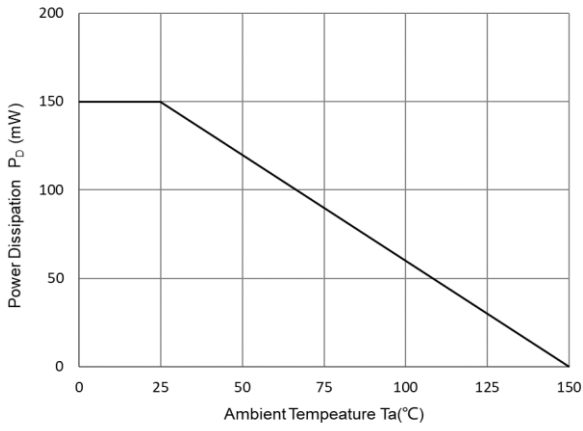

Fig 2: Capacitance Capability

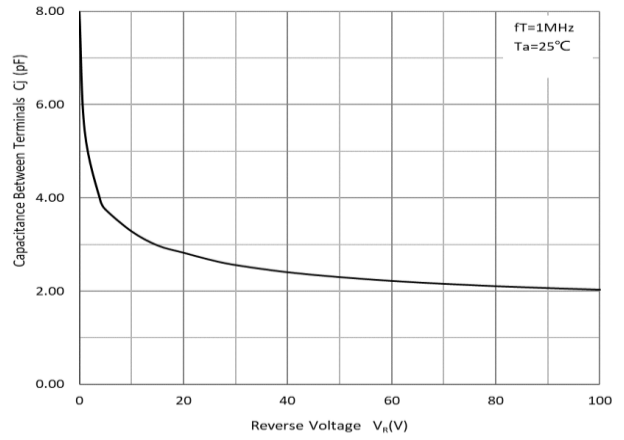

Fig 3: Typical Forward Characteristics

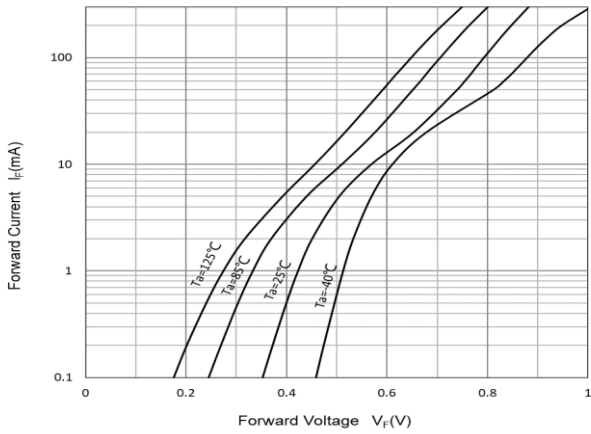
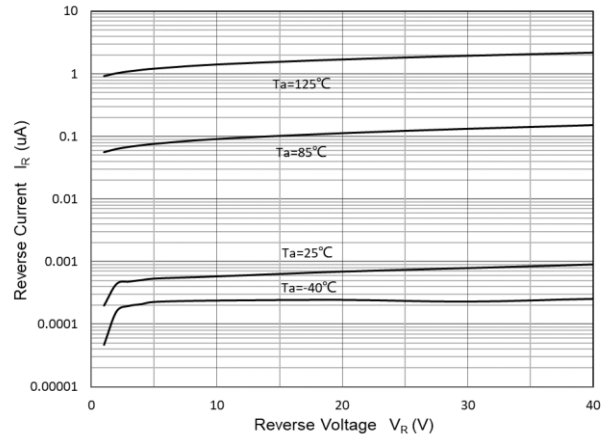

Fig 4: Typical Reverse Characteristics





# BAT41WS

## Ordering Information

Preferred P/N	Packing code	Unit weight(g)	Minimum package(pcs)	Inner box quantity(pcs)	Outer carton quantity(pcs)	Delivery mode
BAT41WS	F2	Approximate 0.0048	3000	30000	120000	7" reel
BAT41WS	F3	Approximate 0.0048	10000	/	210000	13" reel

## Outline Dimensions

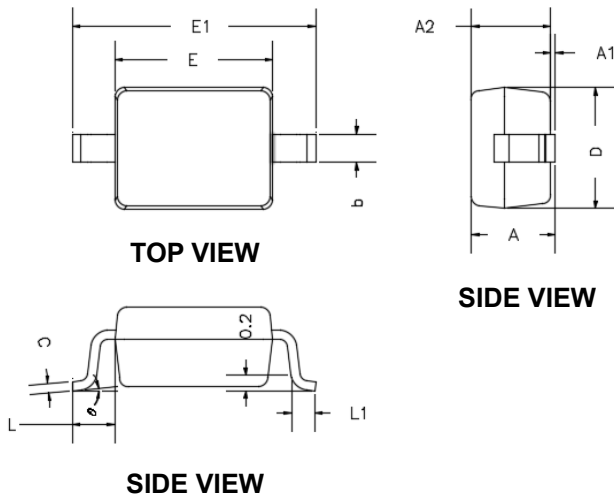

DIMENSIONS				
DIM	INCHES		MM	
	MIN	MAX	MIN	MAX
A	---	0.0393	---	1.0000
A1	0.0000	0.0039	0.0000	0.1000
A2	0.0314	0.0354	0.8000	0.9000
b	0.0098	0.0157	0.2500	0.4000
c	0.0031	0.0059	0.0800	0.1500
D	0.0472	0.0551	1.2000	1.4000
E	0.0629	0.0709	1.6000	1.8000
E1	0.0984	0.1063	2.5000	2.7000
L	0.0187TYP		0.475TYP	
L1	0.0098	0.0157	0.250	0.400
θ	0°	8°	0°	8°

## Suggested Pad Layout

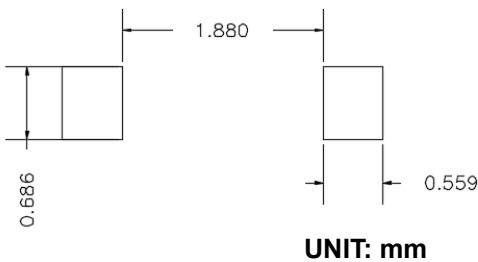

### Note:

- All dimensions are in millimeters (mm) unless otherwise specified.  
[所有尺寸均以毫米为单位，除非另有说明]
- General tolerances:  $\pm 0.10\text{mm}$  unless otherwise specified.  
[通用公差为 $\pm 0.10\text{mm}$ ，除非另有说明]
- Dimensions and tolerances per ASME Y14.5M-2018.  
[尺寸和公差遵循 ASME Y14.5M-2018 标准]
- All dimensions shown are exclusive of burrs and gate residues.  
Burr and gate vestiges shall not exceed 0.15 mm in maximum.  
[所有尺寸均不包括毛刺和浇口残留。毛刺与浇口残留的尺寸最大不得超过 0.15mm]
- Dimension b does not include dambar protrusion of max 0.100 mm per side.  
[尺寸b不包括单边最大0.100 MM的中筋凸出部分]
- Dimensions D and E are the overall extreme outer dimensions of the mold compound. These dimensions exclude mold flash, lead flash, protrusions and burrs but include the maximum allowable mold mismatch.  
[D和E是塑封体的外部极限尺寸，不包括包封溢料、内引线溢料、凸出部分以及胶体毛刺，但是包含了包封错位的最大尺寸]
- Formed leads shall be planar with respect to one another within a maximum of 0.076 mm relative to the seating plane.  
[成型的管脚应为同一平面，共面性最大为0.1mm]



## BAT41WS

---

### Disclaimer

The information presented in this document is for reference only. Yangzhou Yangjie Electronic Technology Co., Ltd. reserves the right to make changes without notice for the specification of the products displayed herein to improve reliability, function, or design or otherwise.

The product listed herein is designed to be used with ordinary electronic equipment or devices, and not designed to be used with equipment or devices which require high level of reliability and the malfunction of which would directly endanger human life (such as medical instruments, transportation equipment, aerospace machinery, nuclear-reactor controllers, fuel controllers and other safety devices), Yangjie or anyone on its behalf, assumes no responsibility or liability for any damages resulting from such improper use of sale.

This publication supersedes & replaces all information previously supplied. For additional information, please visit our website [http:// www.21yangjie.com](http://www.21yangjie.com) , or consult your nearest Yangjie's sales office for further assistance.